



GRAPHPLEX
S I G N S
Sign Design & Manufacture

Expert Design & Manufacture of
Municipality and Commercial Signage
Since 1970



GRAPHPLEX S I G N S

Sign Design & Manufacture

2830 North 28th Terrace
Hollywood, FL 33020

signs@graphplex.com
www.graphplex.com

O 954.920.0905
F 954.920.0906

STATE LICENSE | EC13004975

GraphPlex Signs specializes in the fabrication and installation of exterior and interior signs. For over 35 years, we have been one of south Florida's leading suppliers of illuminated and non-illuminated custom signs.

Our state-of-the-art 10,000 square foot facility manufactures all types of signs including street signs, monument signs, channel letters, dimensional letters, ADA signs, logos, wayfinding signs, directories and banners.

We have an impressive client list that continues to grow with municipalities, property management companies, condominiums, hotels, communities, retailers, Advertising/Marketing firms as well as countless small businesses.

GraphPlex is centrally located in Hollywood on Interstate 95 and Sheridan Street. We are state licensed and insured and have the expertise to permit your project in a timely, efficient manner.

When it comes to your signage needs, GraphPlex Signs is your one stop shop for custom signs at affordable prices.





MUNICIPALITIES

GraphPlex has the experience of working with municipalities in numerous fashions. From sign consultants to original project evolution, GraphPlex has the “know how” to work with you.



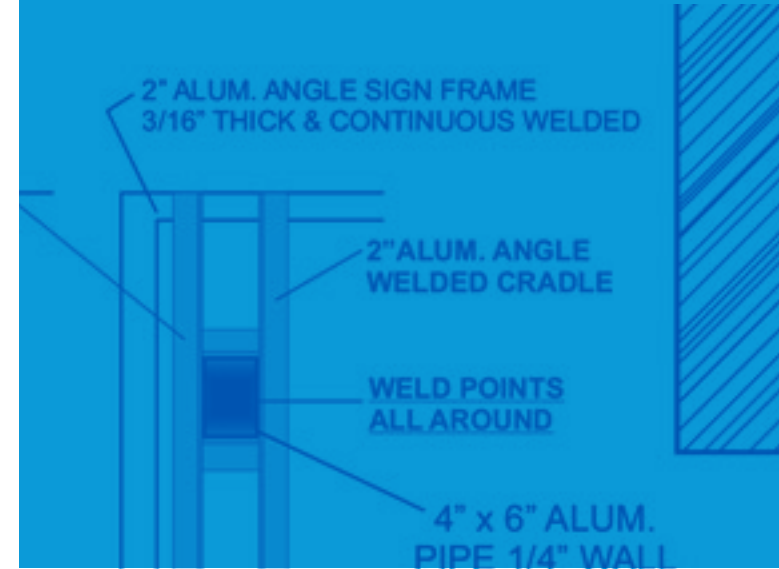

IDENTIFICATION

We have the ability to interpret and create your plan or provide designs in a creative environment through one of our staff designers. Our on-site team of designers and fabricators are here to produce attractive, quality signs.

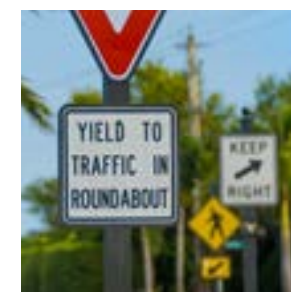
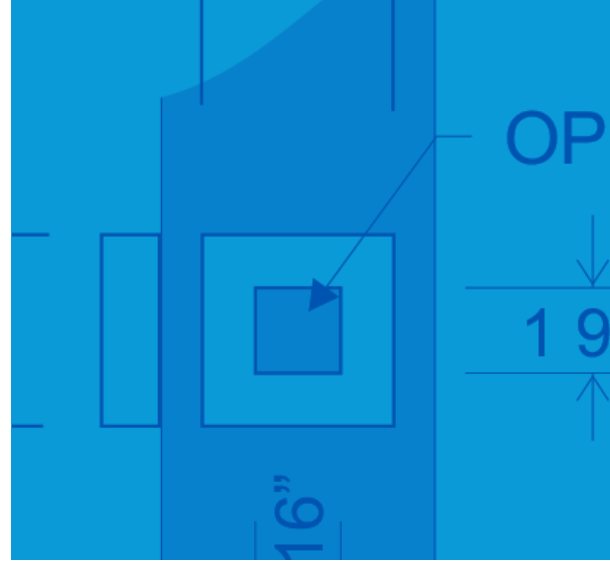

RESIDENTIAL WAYFINDING

The team has recently produced wayfinding signs, custom street signs and monument signs for many of our municipality clients such as the City of Weston, City of Coral Springs, City of Bay Harbor Islands and the City of Sunny Isles Beach to name a few.

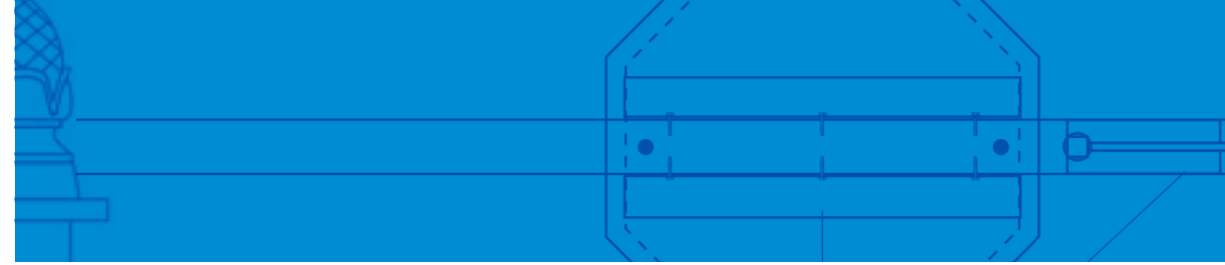

SIGNAGE TYPES

Identification signs
Wayfinding signs
Entry signs

Custom Street signs
Monument signs
Directional signs

Indexing signs
Dimensional letters
Illuminated letters



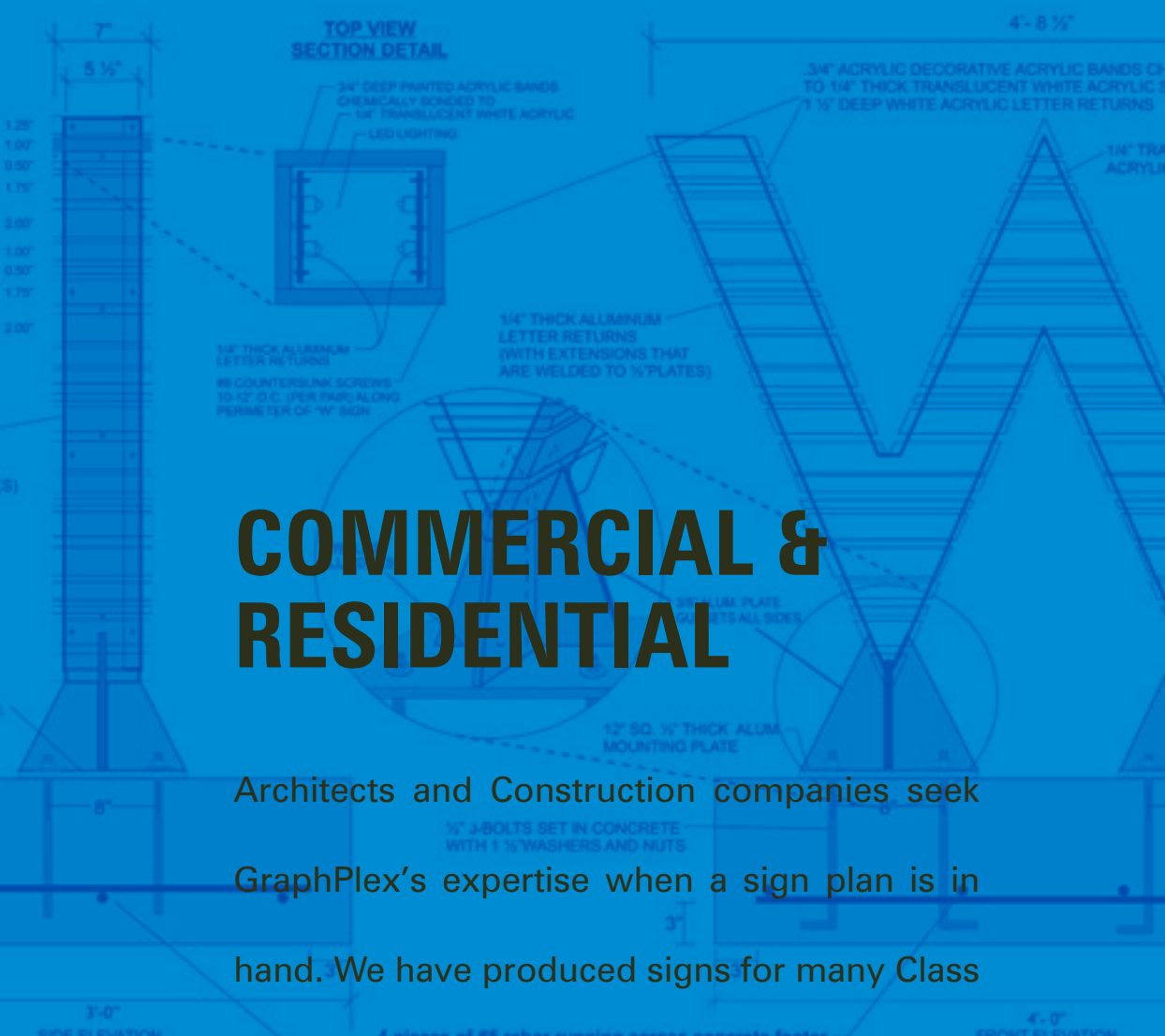

COMMERCIAL & RESIDENTIAL

Architects and Construction companies seek GraphPlex's expertise when a sign plan is in hand. We have produced signs for many Class A building's high end clients such as W Hotels, numerous Trump properties, DYL Group and many more. Our team of fabricators have the experience to produce unique signs that are both memorable and long lasting.



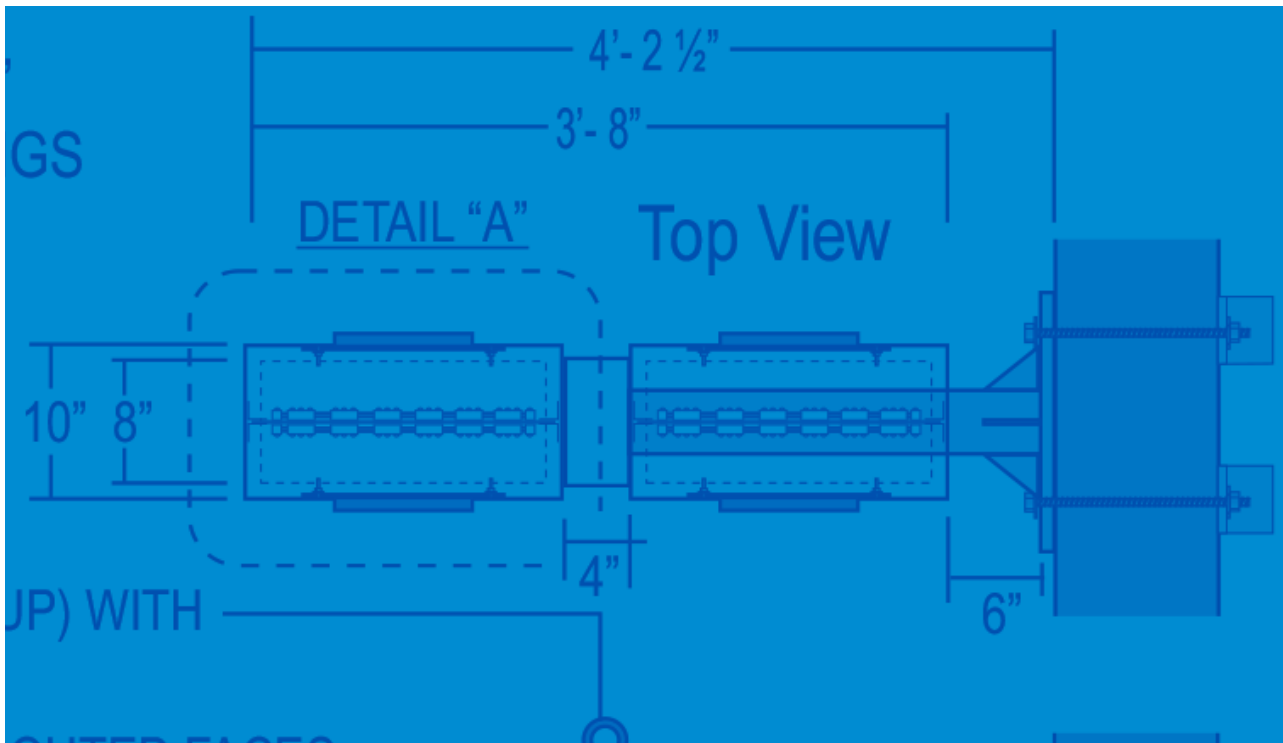
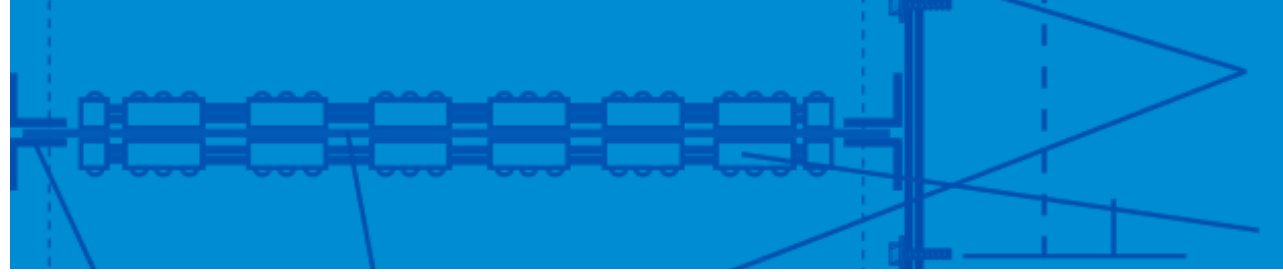

UNDERSTANDING BUSINESS NEEDS

Our team of project managers, designers and fabricators take great care in understanding our clients' input and implementing distinct signs that are built with detailed and skilled craftsmanship.

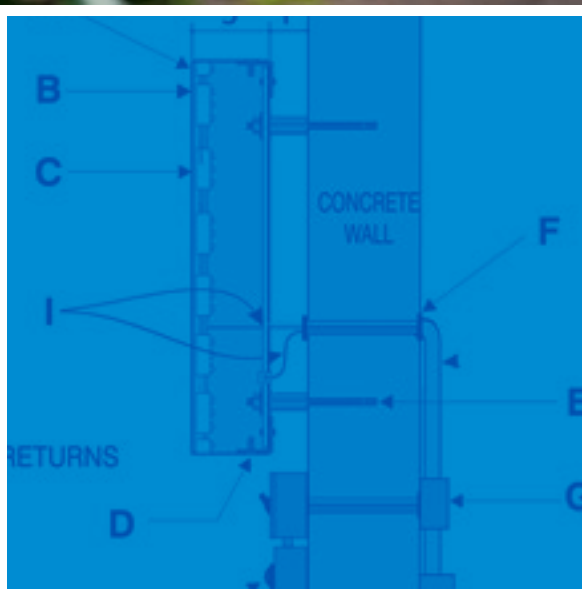
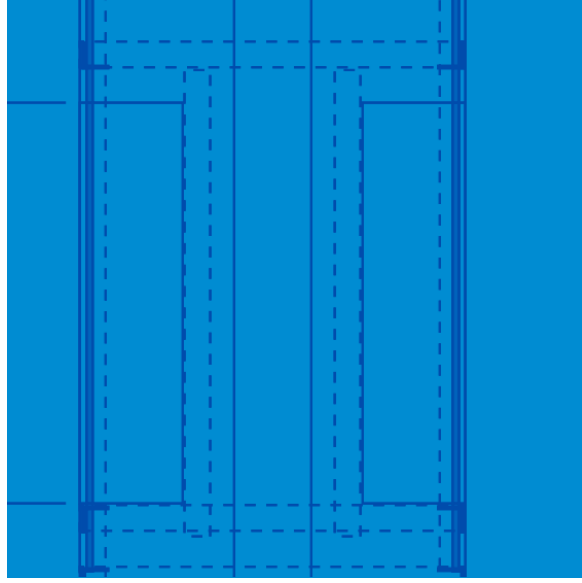

SIGNAGE TYPES

- Monument signs
- ADA signs
- Directional signs
- Identification signs
- Interior signs
- Exterior signs
- Illuminated signs
- Non-illuminated dimensional signs
- Channel letters
- Reverse channel letters
- Directories
- Sandblasted signs



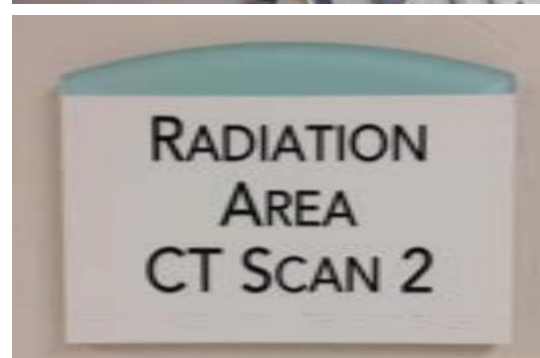

NAVIGATION

GraphPlex has the experience to guide you through the process of designing wayfinding or directional signs that are easy to follow. From getting you to the right building and into the right space, day or night, we can design signs that make it easy for your guests or customers to arrive safely in a simple and informed manner.

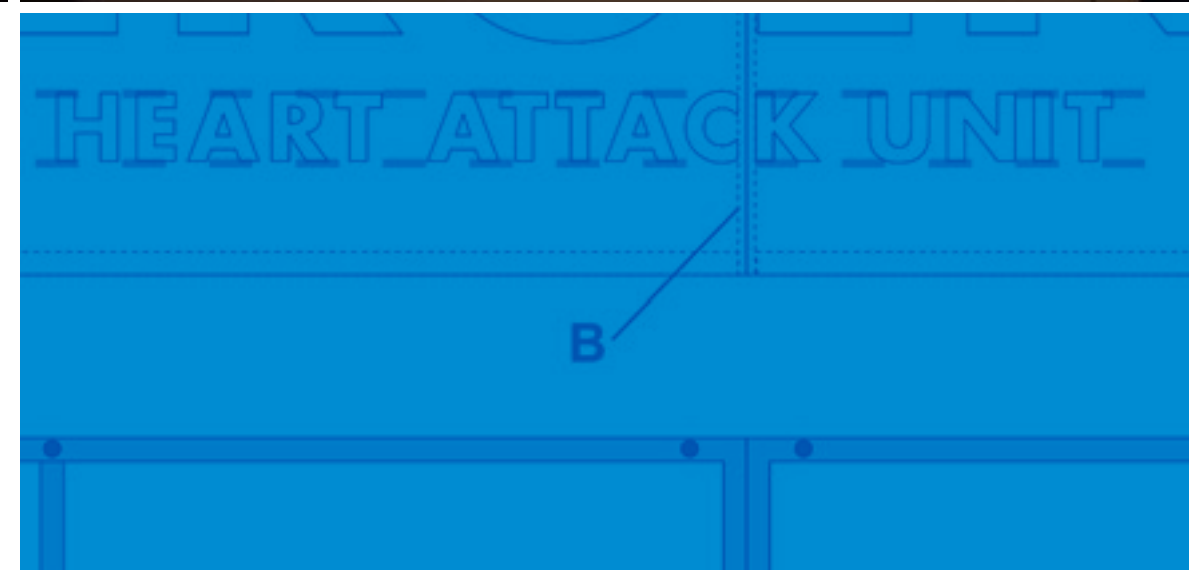



PRODUCTION

For over 40 years, our team at GraphPlex Signs has been producing quality signs at affordable prices. We pride ourselves in our ability to facilitate the complete signage process. Whether you have a design in mind or are starting at square one, we will help you resolve all your signage needs. Our expert staff can assist you with DOT-compliance, ADA compliance, required AHCA signage and Department of Health signs (Pool and Spa Rules).

ILLUMINATION
A: 1/8" P
TO
B: 1 1/2" X
C: 6" DE
(3/16
D: #10 S
E: 3/4" TR
LOGO



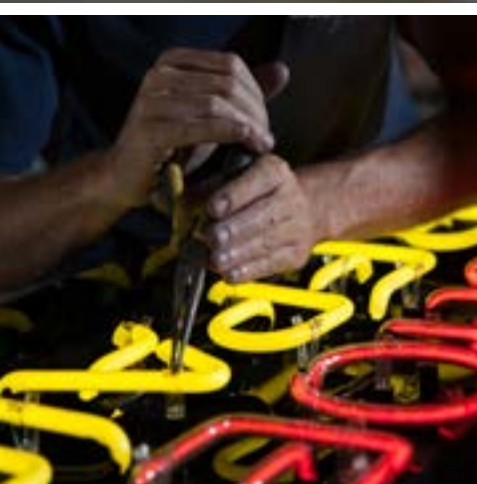

CRAFTSMANSHIP

With countless years of experience combined, our sign team has the expertise in working with metals, acrylics and woods. GraphPlex installers will expertly install your vinyl graphics, street signs, ADA signs, or wall signs in a precise and professional manner.



**GRAPHPLEX
SIGN S**

Sign Design & Manufacture

2830 North 28th Terrace
Hollywood, FL 33020

signs@graphplex.com
www.graphplex.com

O 954.920.0905
F 954.920.0906

STATE LICENSE | EC13004975

Jack Gervais
Chief Operating Officer

2830 North 28th Terrace
Hollywood, FL 33020

jack@graphplex.com
www.graphplex.com

C 954.549.5566
O 954.920.0905
F 954.239.6872



**GRAPHPLEX
SIGN S**

Sign Design & Manufacture



Graphplex Signs

2830 North 28th Terrace
Hollywood, FL 33020

signs@graphplex.com
www.graphplex.com

T 954.920.0905
F 954.920.0906